

WEATHER CONTROLLER

WT100

FOR CONTROL TEMPERATURE HEATING CIRCUIT



OPERATIONS AND INSTALLATION MANUAL

VERSION: 1.4

SOFTWARE VERSION:

v01.XX.XX

TABLE OF CONTENTS

1	SAFETY INFORMATION.....	4
2	GENERAL INFORMATION.....	5
3	INFORMATION ABOUT DOCUMENTATION.....	5
4	DOCUMENTATION STORAGE.....	5
5	USED SYMBOLS.....	5
6	WEEE DIRECTIVE 2012/19/UE.....	5
7	OPERATING THE REGULATOR.....	8
7.1	DESCRIPTION OF DISPLAY MAIN WINDOW.....	8
7.2	CONTROLLER OPERATION.....	8
8	USER'S MAIN MENU.....	9
8.1	WORK MODE.....	9
8.2	SCHEDULE.....	9
8.3	SUMMER/WINTER FUNCTION.....	10
8.4	GENERAL SETTINGS.....	10
8.5	INFORMATION.....	10
8.6	ADDITIONAL FUNCTIONS.....	10
9	HYDRAULIC SCHEMES.....	12
9.1	SCHEME 1.....	12
9.2	SCHEME 2.....	13
9.3	SCHEME 3.....	14
10	INSTALLATION OF THE CONTROLLER.....	15
10.1	ENVIRONMENTAL CONDITIONS.....	15
10.2	INSTALLATION REQUIREMENTS.....	15
11	EXTERNAL CIRCUITS CONNECTION.....	16
12	CONNECTING ELECTRICAL SYSTEM.....	17
12.1	FIXING THE EXTERNAL WIRES.....	17
12.2	CONNECTION OF TEMPERATURE SENSORS.....	18
12.3	CONNECTING WEATHER SENSOR (EXTERNAL).....	18
12.4	TEMPERATURE SENSOR CHECKING.....	19
12.5	CONNECTING A ROOM THERMOSTAT.....	19
12.6	CONNECTING A HEAT SOURCE.....	19
13	SERVICE MENU.....	20
14	SERVICES SETTINGS.....	21
14.1	HEATING CIRCUIT.....	21
14.2	HEAT SOURCE.....	21
14.3	PROTECTION.....	22
14.4	OTHER PARAMETERS.....	22
15	FUNCTION.....	23
15.1	PROMPTS.....	23
15.2	HEATING CIRCUIT.....	23
15.3	FROST PROTECTION.....	24
15.4	POWER STOPPAGE.....	24
15.5	PREVENTION COOLING.....	24
15.6	PUMP ANTI STANDSTILL FUNCTION.....	25
15.7	FUSE REPLACEMENT.....	25
16	STORAGE AND TRANSPORT CONDITIONS.....	25
17	TECHNICAL DATA.....	25

1 SAFETY INFORMATION



Requirements concerning safety are listed in particular sections of this instruction. Apart from them it is necessary to fulfill the following requirements.

- Prior to starting the assembly, repairs or maintenance and during the execution of any connection works, it is necessary to switch off the mains supply and make sure that no terminals no electrical wires are energized.
- After deactivating the controller, terminals of the controller can be under a dangerous level of voltage.
- The controller can be utilized only in accordance with its intended use.
- Values of programmed parameters must be set in accordance with a particular building and hydraulic system.
- Controller can be assembled only by qualified installer and in accordance with currently valid standards and regulations.
- The controller is not an intrinsically safe device. It means that in case of failure it can be a source of sparks or high temperature which surrounded by ashes or flammable gases can cause fire or explosion.
- Modification of the programmed parameters should be made only by a person who read this manual.
- Use only in heat circulation system made in accordance with currently valid regulations.
- Electrical system including the controller should be protected with fuse selected in accordance with used loads.
- The controller cannot be used with damaged housing.
- Never make any modifications in controller structure.
- The controller has electronic disconnection for connected devices (operation 2.B according to PN-EN 60730-1).
- Before you open casing, first disconnect power supply from the unit.
- The controller must be installed in accordance with the requirements of EN 60335-1 standard, by qualified and authorized technician.
- Short circuit at the outputs leads to damage to the device (not output COM-NO).
- Do not operate the unit when it is malfunctioning or was repaired by unauthorized persons.
- Do not mount the unit on flammable materials.

2 General information

Weather controller WT100 is designed to control the temperature in the heating circuit with the valve 3 or 4-way equipped with a drive-controlled 3-point with the possibility of connecting additional circulation pump and control the heat source through a dry contact. Main functions performed:

- weather control - the preset temperature heating circuit is determined on the basis of the programmed heating curve and the measured outside temperature,
- automatic detection season heating,
- work with a room thermostat
- controlling the heat source
- implementation of the return temperature protection (against low temperature of the return water) - protection from boiling water in the boiler (coal boiler) in the short-circuit of the boiler.

The controller is equipped with a timer (clock operation is maintained for 48 hours with the power off the controller).

Regulator is easy to operate in an intuitive manner. It may be used in households and other similar premises and in light industry facilities.

3 Information about documentation

The regulator manual is divided into two parts: for user and fitter. Yet, both parts contain important information, significant for safety issues, hence the user should read both parts of the manual.

We are not responsible for any damages caused by failure to observe these instructions.

4 Documentation storage

Please keep this operation and assembly manual and other valid documentation in a safe place for future reference. In case of moving or selling the device, hand this documentation over to a new user or owner.

5 Used symbols

The following graphical symbols are used in the manual:



- useful information and tips,



- useful information concerning property damage, health or life threat for people or pets.

Caution: important information were labeled with the aforementioned symbols in order make the manual easier to understand. However it does not release the user nor installer from responsibility of complying with requirements which are not labeled with any symbols!

6 WEEE Directive 2012/19/UE

Purchased product is designed and made of materials of highest quality.

The product meets the requirements of the **Directive 2012/19/EU of 4 July 2012 on waste electrical and electronic equipment (WEEE)**, according to which it is marked by the symbol of crossed-out wheeled bin (like below), meaning that product is subjected to separate collection.



Responsibilities after finishing a period of using product:

- dispose of the packaging and product at the end of their period of use in an appropriate recycling facility,
- do not dispose of the product with other unsorted waste,
- do not burn the product.

By adhering obligations of waste electrical and electronic equipment controlled disposal mentioned above, you avoid harmful effects on the environment and human health.

REGULATOR INSTRUCTION MANUAL

WT100

7 Operating the regulator

The controller has **TOUCH&PLAY** system that facilitates its operation. Encoder is operated by its rotating and pressing.

To start the controller, keep pressed encoder knob for 3 seconds. When the message "Active regulator?" must set **YES**. The screen will display the main screen. Another press will call the main menu.

Rotate the encoder TOUCH&PLAY increases or decreases the value parameter being edited. It is the element of quick operating of the regulator. Short press the encoder to input the selected parameter or approval of the selected value.

Pressing for 3 seconds to exit the selected parameter or do not accept the selected value.

All controller settings are made through a rotary system MENU. After calling up the main menu on the screen will display a screen with icons representing the functions of the controller.

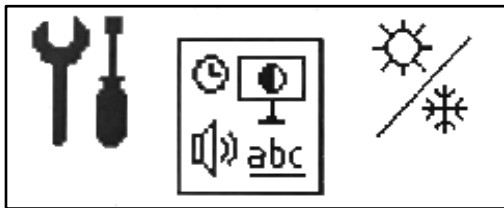

7.1 Description of display main window

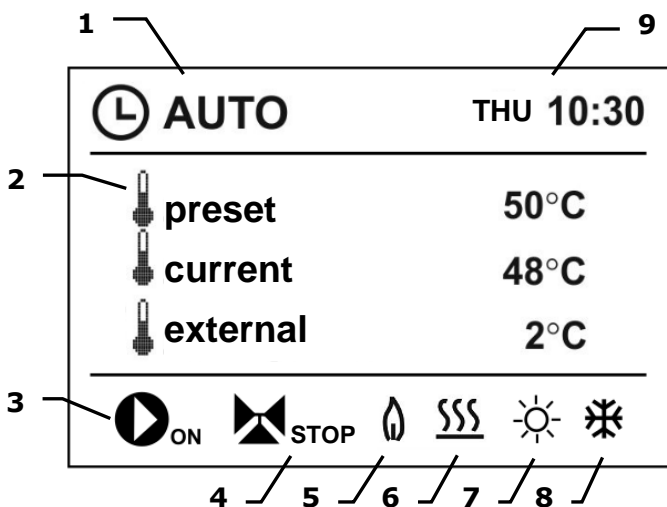

1. Regulator working modes:



- OFF mode



- AUTO mode (work with clock)



- COMFORT mode



- ECONOMY mode



- AUTO-ECO mode

2. temperature value: preset, current and external (weather)

3. work pump CH: ON, OFF

4. valve mixer actuator position: ON – open, OFF – closed, STOP - off.

5. working heat source (boiler switched on)

6. information from the room thermostat:

No icon – the thermostat is off,



- Heating – room temperature below the preset,



- No heating – room temperature above the preset.

7. active SUMMER mode

8. active frost protection function

9. clock time and weekday.

7.2 Controller operation

Heat source:

The controller controls the operation of heat source, e.g. an automatic gas, oil or pellet boiler, by activating or deactivating it according to a heat demand of the central heating system. Switching on and switching off the heat source may be programmed in intervals times, in the **Schedule** menu.

Heating circuit:

The controller controls the operation of one direct heating circuit (radiators or floor) with mixing valve and circulating pump. The control heating circuit (decrease preset temperature) can be programmed in intervals times, in the **Schedule** menu.

The method of temperature control:

- *Weather control* - on the basis of the signal from the external (weather) temperature sensor is calculated water temperature in the heating circuit. As a result, despite the changing external temperature room temperature in heated rooms is maintained at a preset level.

- *Continous control* - the preset temperature of water in the heating circuit is constant at the set value, without the impact of changes in external temperature.

 **Preset temperature setting in Service menu** (described in the manual).

8 User's main menu

Main menu
Information
Work mode
<ul style="list-style-type: none"> • OFF • Auto • Comfort • Economy • Auto-Eco
Schedule
<ul style="list-style-type: none"> • Circuit • Heat source
Summer\Winter
<ul style="list-style-type: none"> • SUMMER mode: OFF, ON, Auto • Summer mode ON temp. [range 5..35°C, fact.20] • Summer mode OFF temp. [range 1..22°C, fact.18]
General settings
<ul style="list-style-type: none"> • Clock • Screen brightness • Screen contrast • Sound • Language
Service settings

8.1 Work mode

This option is used to switch on the respective modes of work of the controller according to user preferences.

To change the work mode to select:



Main menu → Work mode

- **OFF**  - the controller turns off the heating circuit. The frost protection function remains active as long as it is enabled in the service menu.

 Activating this work mode also turns off the heat source. The heat source is not turns off during active function heating buffer.

- **Auto**  - preset temperature in the room changes according to the time program. In periods of "day" is setting *Preset temperature*. In periods of "night"

is setting (*Preset temperature - Decrease of work mode*).

- **Comfort**  - preset temperature in the room is constant and corresponds to the entered value *Preset temp*.
- **Economy**  - preset temperature in the room is constant and corresponds to the entered value temperature (*Preset temperature - Decrease of work mode*).
- **Auto-Eco**  - preset temperature in the room changes according to the time program. In periods of "day" is set *Preset temperature*. In periods of "night" heating circuit is completely turns off. The frost protection function remains active as long as it is enabled in the Service menu.

8.2 Schedule

The time intervals allow the introduction of decrease preset temperature within a specified time period for the heating circuit and the turns on or turns off heat source, eg. at night or when user leave the heated rooms. As a result, the preset temperature can be lowered automatically without loss of heat comfort in the room.



Activation of time intervals in:



Main menu → Schedule

and select a time schedule for the heating circuit or heat source.

Decrease night time for the heating circuit and the work of heat sources can be defined separately for every day of the week: *Monday - Sunday*.

Select the decrease of the preset temperature and the beginning and end of a given time interval.

Working of decrease temperature in the time intervals are designated as "**day**"  - this corresponds to the *Preset temperature* and "**night**"  - corresponds to the *Decrease of work mode*.

Action at intervals for the heat source are marked as  - heat source is turned on and  - a heat source is turned off.

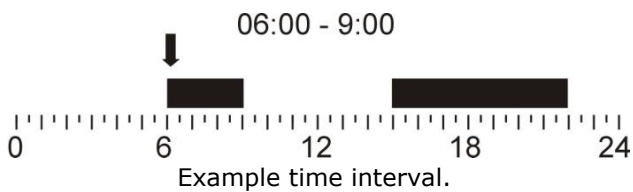

In the example below, a "night" period will last from 00:00 till 06:00. "day" period will last between 06:00 – 09:00. From 15:00 to 22:00 the "day" period was entered. "night" period will last from 22:00 to 00:00.

 An interval is ignored if the decrease value is set to "0", even if its range of hours is specified.

8.3 Summer/Winter function

The SUMMER / WINTER function is responsible for the automatic or manual turns on of heating. It also allows the loading of the HUW container in the summer, without the need to heat the central heating system. Must set the parameter *SUMMER mode = ON*, in:

Main menu → Summer/Winter → Summer mode



In SUMMER mode, all heat recipients may be OFF, therefore, make sure the boiler will not be overheated.

If the external temperature sensor is connected SUMMER function can be turned on automatically using the *Auto* parameter, including temperature settings for the *Summer mode ON temp.* and *Summer mode OFF temp.*

8.4 General settings

In general settings, can change the settings date, time, brightness and contrast of the screen. Can turn on and turn off the sound, and change the language menu for the controller.

8.5 Information

The information menu allows to view information temperatures and allows to see which devices are currently enabled. By turning the encoder TOUCH&PLAY changes between successive windows of information.

8.6 Additional functions

Easier support for the user, eg. if turn off support for the heat source to all the features associated with this parameter disappear - you can then control the heating circuit. It's the same when you turn off the heating circuit - be able to control the heat source with using a heat source contact and the heat source sensor.

There is also possible to control the heating circuit with mixing, with optional thermostat influence the heating circuit.

INSTALLATION MANUAL AND SERVICE SETTINGS

WT100

9 Hydraulic schemes

9.1 Scheme 1

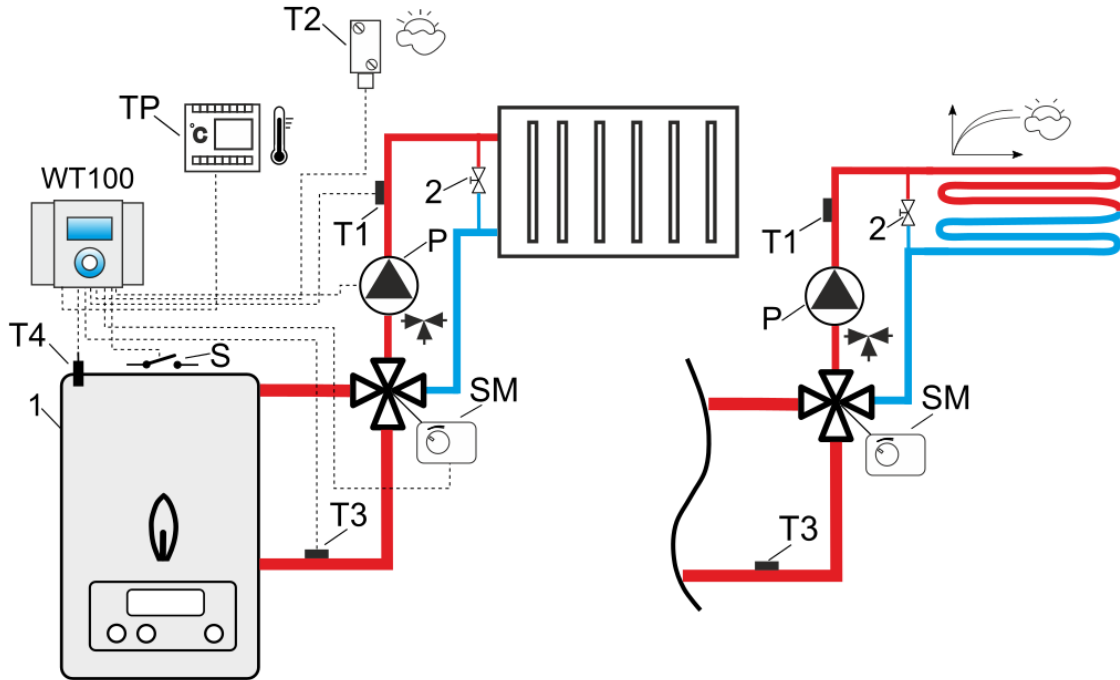

Hydraulic scheme with of the four-way valve controlling the central heating circuit or floor circuit¹

Legend:

- TP – room thermostat (NO-NC)
- T1 – heating circuit temperature sensor type CT10
- T2 – external temperature sensor (weather) type CT6-P
- T3 – return temperature sensor type CT10
- T4 – heat source temperature sensor type CT10
- P – pump heating circuit
- SM – four-way valve + actuator
- 1 – heat source with (S) ON-OFF contact (gas- or oil- boiler)
- 2 – relief valve different pressure.

RECOMMENDED SETTINGS:

Parameter	Setting	MENU
Kind of the system	Radiators system (Underfloor heating)	Service settings → Kind of the system
Max. temperature	80°C (45°C)	Service settings → Heating circuit
Room thermostat	ON	Service settings → Room thermostat
Start pump temp.	55°C (20°C)	Service settings → Heating circuit
Return sensor	ON	Service settings → Protection



In order to improve water flow in gravitational circuit of the boiler use large nominal DN cross-sections of pipes and the four-way valve, avoid numerous elbows and cross-section reductions, apply other rules regarding construction of gravitational systems, e.g. keeping of gradients, etc. In case the return temperature sensor is mounted on the pipe - provide proper heat insulation to isolate it from the environment and improve its thermal contact with the pipe by applying of the thermal paste. The heat source preset temperature has to be high enough to ensure enough heating power for the heating circuits while heating the return water.

¹ The presented hydraulic diagram does not replace central heating engineering design and may be used for information purposes only!

9.2 Scheme 2

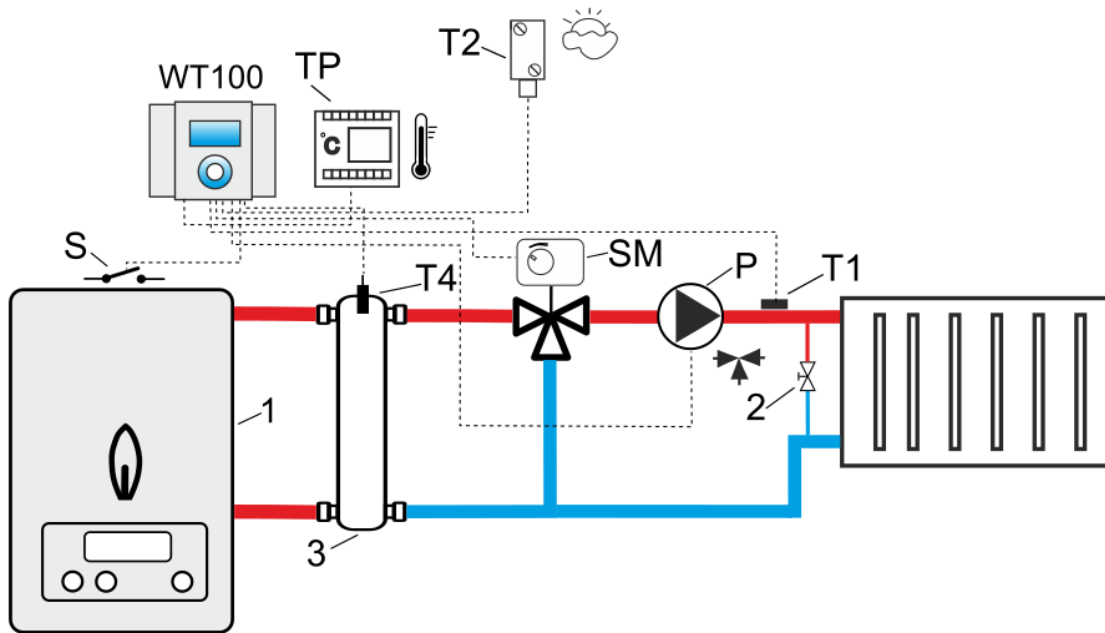

Hydraulic scheme of the three-way valve controlling the central heating circuit (with a hydraulic coupling) ²

Legend:

- TP – room thermostat (NO-NC)
- T1 – heating circuit temperature sensor type CT10
- T2 – external temperature sensor (weather) type CT6-P
- T4 – hydraulic coupling temperature sensor type CT10
- P – pump heating circuit
- SM – three-way valve + actuator
- 1 – heat source with (S) ON-OFF contact (gas- or oil- boiler)
- 2 – relief valve different pressure
- 3 – hydraulic coupling.

RECOMMENDED SETTINGS:

Parameter	Setting	MENU
Kind of the system	Radiators system	Service settings → Kind of the system
Max. temperature	80°C	Service settings → Heating circuit
Room thermostat	ON	Service settings → Room thermostat
Start pump temp.	55°C	Service settings → Heating circuit
Cooling temp.	92°C	Service settings → Heat source

² The presented hydraulic diagram does not replace central heating engineering design and may be used for information purposes only!

9.3 Scheme 3

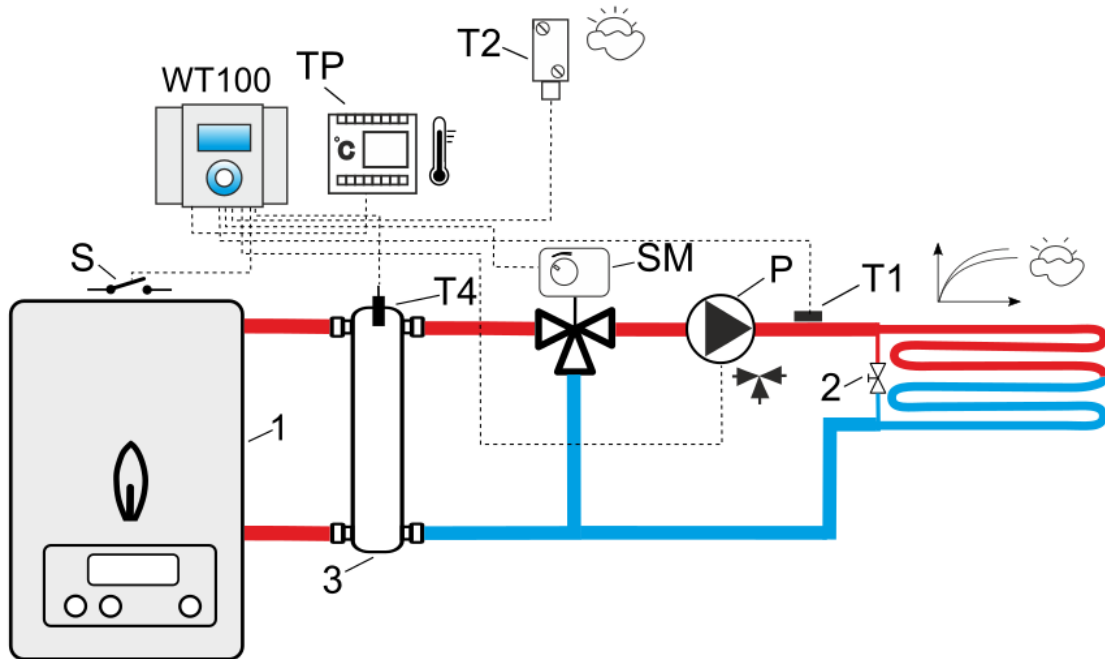

Hydraulic diagram of the three-way valve controlling circuit underfloor heating (with a hydraulic coupling) ³

Legend:

- TP – room thermostat (NO-NC)
- T1 – heating circuit temperature sensor type CT10
- T2 – external temperature sensor (weather) type CT6-P
- T4 – hydraulic coupling temperature sensor type CT10
- P – pump heating circuit
- SM – three-way valve + actuator
- 1 – heat source with (S) ON-OFF contact (gas- or oil- boiler)
- 2 – relief valve different pressure
- 3 – hydraulic coupling.

RECOMMENDED SETTINGS:

Parameter	Setting	MENU
Kind of the system	Underfloor heating	Service settings → Kind of the system
Max. temperature	45°C	Service settings → Heating circuit
Room thermostat	ON	Service settings → Room thermostat
Start pump temp.	20°C	Service settings → Heating circuit

³ The presented hydraulic diagram does not replace central heating engineering design and may be used for information purposes only!

10 Installation of the controller

10.1 Environmental conditions

Due to the risk of fire is prohibited to use the controller in explosive gas and dust environment (eg. coal). Regulator should be separated using appropriate enclosure.

The controller is designed for operation in the environment where only dry conductive contaminations may be present (2 degree of contamination according to PN-EN 60730-1). In addition, the controller may not be used in water condensation conditions and it may not be exposed to water.

10.2 Installation requirements

The controller is designed for vertical wall-mounted installation. External circuit wires are supposed be lead on surface. Mounting hole locations are presented as in the casing.



Before opening the unit casing, disconnect power supply. The unit installation must be done at disconnected voltage.



Controller must be installed by qualified and authorized technician in accordance with EN 60335-1 standard.

For how to open the unit casing see the picture below.

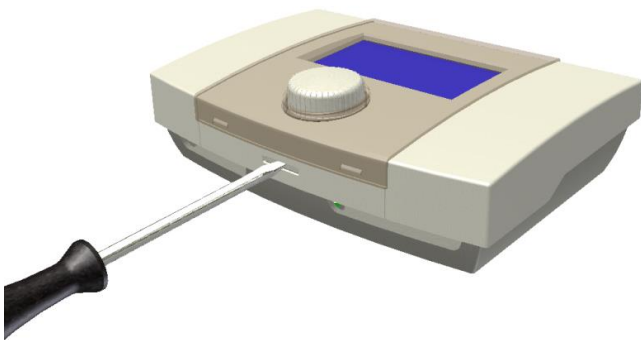

Closing the unit casing see the picture below.

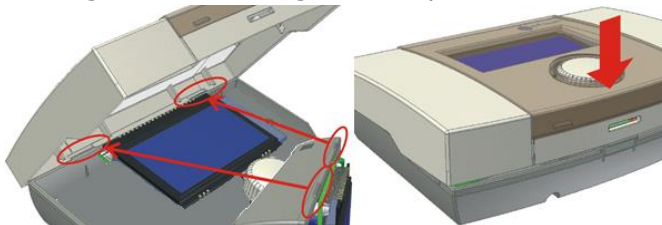

Installations regulator on the wall is shown in the picture below.

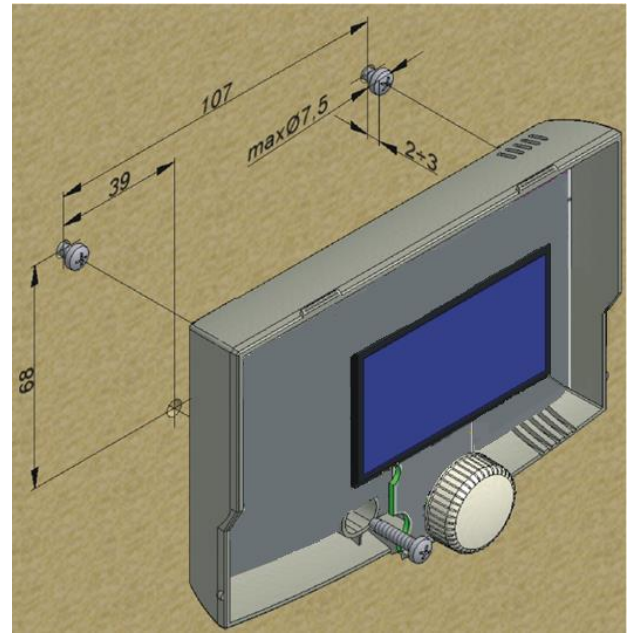

The controller must be installed in a way that:

- it is securely mounted on flat base, using all mounting points,
- degree of protection is ensured suitably to environmental conditions,
- dust and water access is prevented,
- permissible operating temperature is not exceeded for the controller,
- air exchange inside casing is allowed,
- access to dangerous parts is disabled,
- electrical installation, to which the controller is connected, must be equipped with the device that allows disconnection of both supply poles, in accordance regulations that applies to such systems.

11 External circuits connection

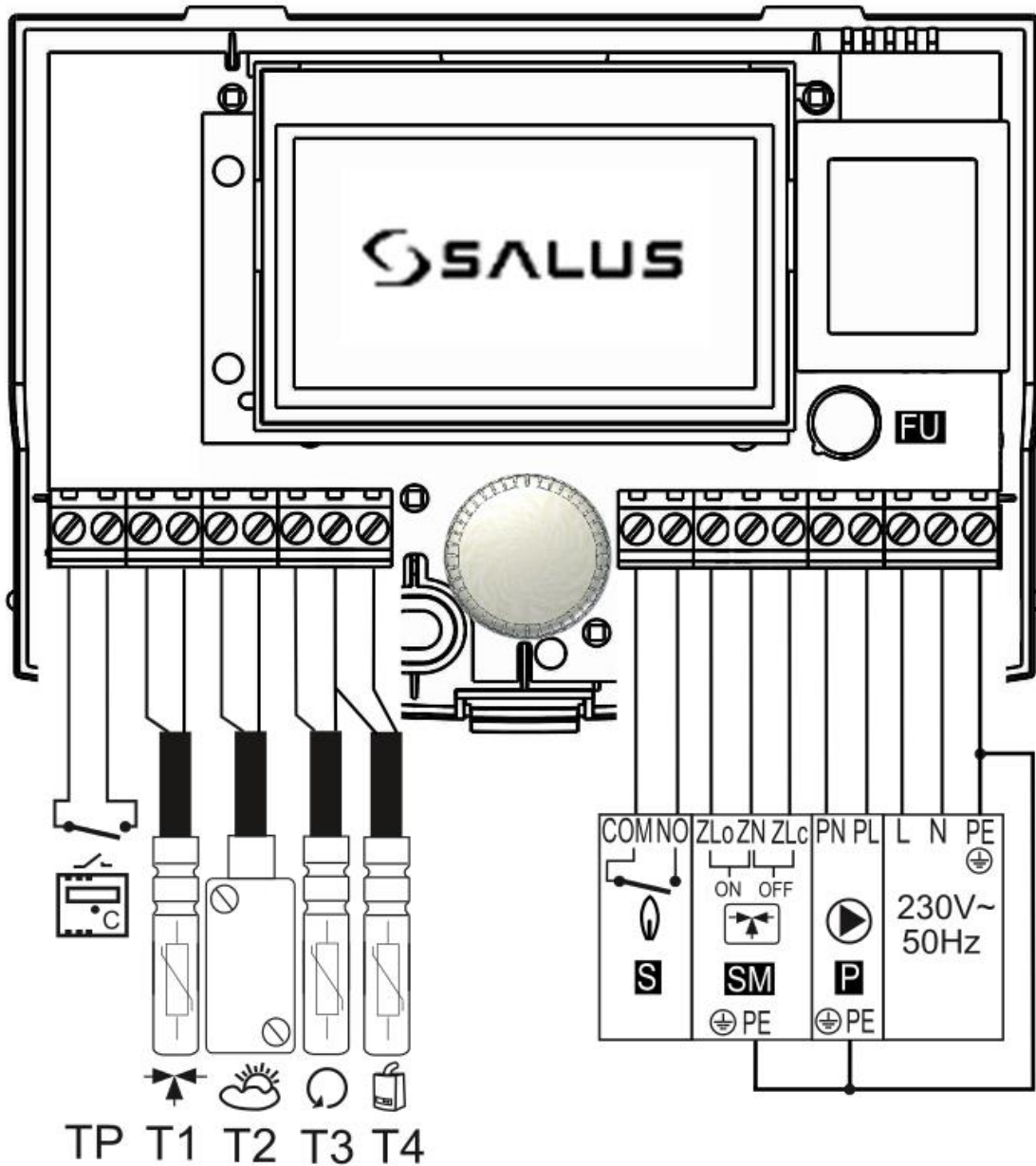

TP – room thermostat (NO-NC),
T1 – temperature sensor mixer heating circuit type CT10,
T2 – external temperature sensor type CT6-P,
T3 – return temperature sensor type CT10,
T4 – heat source temperature sensor type CT10,

L N PE – power supply 230V~, 50Hz,
P – CH pump,
SM – mixer actuator,
S – contact to operate the heating source type ON-OFF,
FU – time-delay subminiature fuse.

The terminals for hazardous voltage: **COM, NO, ZLo, ZN, ZLc, PN, PL, L, N.**

The terminals safe voltage: **TP, T1, T2, T3, T4**

After turned on outputs: SM_OFF; SM_ON; P, on the terminals ZLo-ZN; ZLc-ZN, PL-PN giving is 230V~ voltage. After turned on output S is closed terminal COM with NO – without giving voltage. Detailed description of the output S included in point 12.6.

12 Connecting electrical system

Regulator is designed to be fed with 230V~, 50Hz voltage. Supply is connected to terminals L, N, PE.

The electrical system should be:

- three core (with protective wire PE),
- z in accordance with applicable regulations.

Supply wires must be lead so as their contact with sensor and other low-voltage cabling is prevented, additionally, all cables may not contact surfaces with temperatures that exceed the cables operating temperature limits.

The controller has no PE protective connector, because the controller itself does not require grounding. PE terminals of the pump, mixer actuator shall be connected with PE of supply network, according to periphery instructions and regulation concerning electric systems.



Connecting mains supply 230V~ to terminals for sensors will damage the regulator and creates risk of an electric shock!

Tips of the connected wires, especially power leads, must be secured against splitting by means of insulated clamps, in accordance with the drawing below:

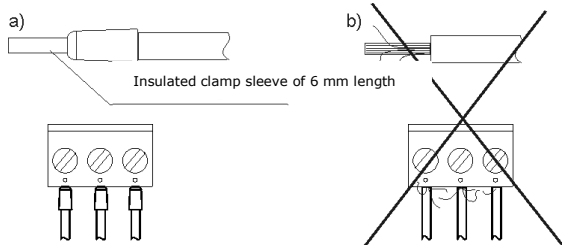

Securing wire tips: a) - right, b) - wrong.

12.1 Fixing the external wires

Electric cables external circuits are predicted for the installation of surface-mounted. A concealed external cable outlet should be provided, as well as protection against the wire being pulled out, loosened or strained, using electric cable tray. It is not allowed to leave any cable leads loose, to roll the excess wire or to bend the wires into acute angles.

It is not allowed to roll the excess wire or to leave disconnected cables inside the regulator housing, as it may lead to damage to the controller.

Example how to install the cables using electric cable trays is shown in the figure below.

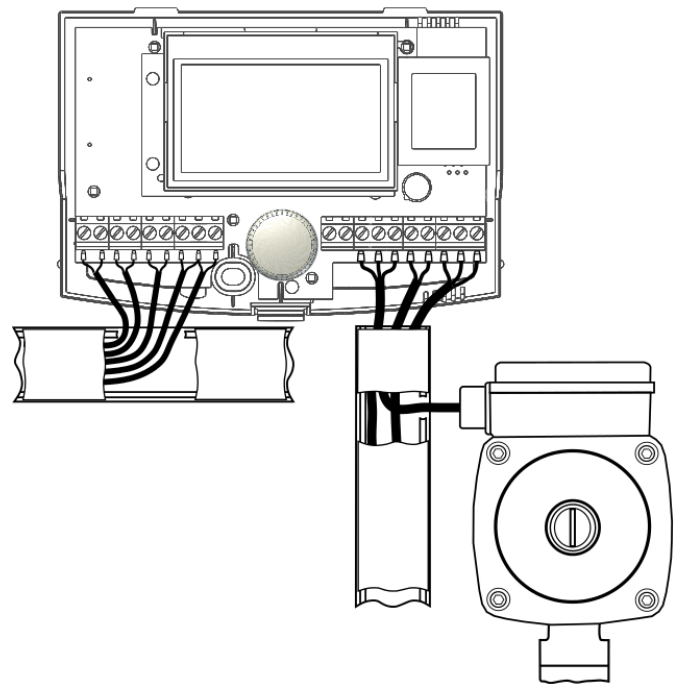

12.2 Connection of temperature sensors

Use only following sensor types: CT10, CT6-P. The use of other sensors is prohibited.

Sensors cables could be extended by a cable with cross-sectional area min. $0,5\text{mm}^2$, a total cable length max. 15m.

Boiler temperature sensor should be installed in thermostatic pipe installed in boiler. Mixer temperature sensor should be installed in sleeve located in stream of running water in pipe, but also it can be installed on the pipe, on condition that it is thermo isolated from the environment.

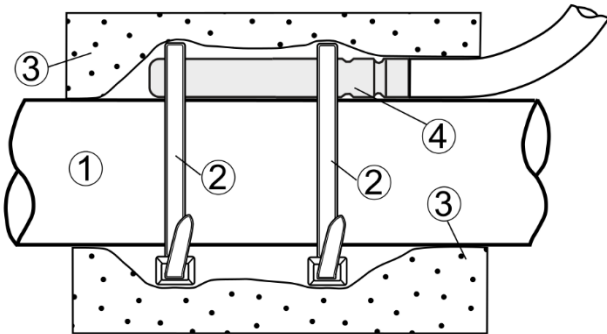

Mounting temperature sensor: 1 - pipe, 2 - clamps, 3 - thermal insulation, 4 - temperature sensor.



Sensor must be protected from getting loose from the surfaces to which they are connected.

Good thermo contact should be maintained between sensors and measured surface. To this purpose thermoleading paste should be used. It is not acceptable to lubricate sensors with water or oil. Wires of sensors should be separated from network electrical wires. In such a case wrong readings of temperature may be shown. Minimum length between those wires should be 100mm. It is not acceptable to allow for contact between wires of the sensors and hot parts of the boiler and heating installation. Wires of the sensors are resistant to temperature not exceeding 100°C .

From the regulator can also be formed to correct an error reading from temperature sensors: circuit heating, external, return and boiler to the nearest $0,1^{\circ}\text{C}$.

The value correction set in:

Service settings → **Temperature correction**

12.3 Connecting weather sensor (external)

The regulator cooperates only with a weather sensor of the CT6-P type. The sensor should be installed on the coldest wall of the building, usually this is the northern wall, under a roof. The sensor should not be exposed to direct sunlight and rain. The sensor should be fitted at least 2m above the ground, far from windows, chimneys and other heat sources which could disturb the temperature measurement (at least 1,5m).

Connect the sensor using cable of $0,5\text{mm}^2$ cross-section, up to 25m long. Polarity of the leads is insignificant. Connect the other end of the cable to the regulator.

Attach the sensor to the wall using tackbolts. To access the tackbolts holes, unscrew the sensor lid.

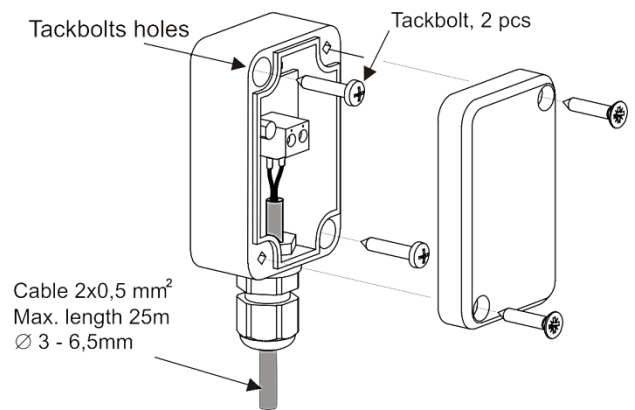

12.4 Temperature sensor checking

Temperature sensors CT10, CT6-P can be checked by measuring their resistance in given temperature. In case of big differences between measured resistance value and values in table below, the sensor should be replaced with a new one.

CT10	
Weather temp. [°C]	Value [Ω]
0	32 554
10	19 872
20	12 488
25	10000
30	8059
40	5330
50	3605
60	2490
70	1753
80	1256
90	915
100	677

CT6-P (weather)	
Weather temp. [°C]	Value [Ω]
-25	901,9
-20	921,6
-10	960,9
0	1000,0
25	1097,3
50	1194,0
100	1385,0
125	1479,4
150	1573,1

12.5 Connecting a room thermostat

Room thermostat (NO-NC) connected to the control affects the heating circuit.

The thermostat after contact opening reduces the preset temperature heating circuit about the service value *Decrease of thermostat* or can turn off the pump in the parameter *Off by thermostat*. The values of the parameters must be chosen so that when of working the room thermostat (contact opening) the temperature in the room dropped.

12.6 Connecting a heat source

COM-NO terminals are used to connect the contact heat source (no voltage) that turns on and off the heat source. The heat source can be automatic boiler gas or oil, which has a contact ON-OFF. Terminals COM-NO does not have galvanic isolation of 230V ~ and can

therefore only serve to disconnect circuit voltage of 230V ~. Use separate relay in the event of having to disconnect circuits at low voltage.



Risk of electric shock caused by current from a heat source. Disconnect the controller and heat source electrical supply and make sure there is no dangerous voltage on terminals.

Protect yourself against incidental generation of supply voltage!

Connection to heat source (gas or oil boiler) should be done by a qualified installer, according to technical data of this boiler.

13 SERVICE MENU

Entrance to the service menu:

Password → **[0000]** → **OK**

Services settings	range	fact.
Heating circuit		
Heat source		
Protection		
Room thermostat	Yes/No	No
Temperature correction:		
• T1 Circuit sensor	-4..+4°C	0
• T2 External sensor	-4..+4°C	0
• T3 Return sensor	-4..+4°C	0
• T4 Boiler sensor	-4..+4°C	0
External sensor	Off/On	On
Manual control		
Screed drying:		
• Active	Yes/No	No
• Program selection: P1-P7	P1..P7	P1
Restore defaults settings	Yes/No	No

Heating circuit	range	fact.
Support	Off/On	On
Kind of the system:		
• Radiators system		Und.
• Underfloor heating		
Control method:		
• Weather control		Weat.
• Continous control		
Weather control *:		
• Heating curve		
• Curve parallel move	-15..15K	0
Preset temperature	20..40°C	35
Decrease of work mode	0..15K	10
Decrease of thermostat *	0..30K	10
OFF by thermostat*	Yes/No	Yes
Start pump temp.	10..70°C	35
Min. temperature	5..40°C	20
Max. temperature	20..50°C	40
Valve full opening time	60..200s	140
Valve input dead zone	0.0..2.0K	1.0
Valve dynamic	1..6	2
Valv delay	30..255	200

Heat source	range	fact.
Support	Off/On	On
Histeresis	1..30K	8
Min. temperature	10..70°C	30
Max. temperature	50..90°C	75
Buffer	Yes/No	No
Buffer preset temp.*	30..75°C	60
HW priority	Yes/No	No
Cooling temp.	80..100°C	88
OFF by thermostat*	Yes/No	No
Increase temp.	1..20°C	5

Protection	range	fact.
Return sensor	Off/On	Off
Min. temperature*	30..65°C	40
Histeresis*	2..15K	8
Closing the valve*	0..50%	10
Frost protection	Off/On	On
Frost protection delay*	1..10h	4
Frost protection temp.*	5..10°C	7

* not available when not connected the corresponding sensor, the parameter is hidden or is not appropriate settings in the menu.

14 Services settings

14.1 Heating circuit

Support	ON or OFF supporting the heating circuit (radiators or underfloor) by the controller.
Kind of the system	Selecting the type of heating installation: <i>Radiators system</i> or <i>Underfloor heating</i> .
Control method	<ul style="list-style-type: none"> <i>Weather control</i> – preset temperature of water circulating in the heating circuit reference is with regard to indications external temperature sensor. The parameter is invisible when not connected external temperature sensor. When the external temperature sensor is defective or not connected will automatically change the <i>Control method</i> on <i>Continous control</i>. <i>Continous control</i> – maintain is a constant preset temperature of circulating water.
Weather control	<p>Heating circuit control depending on external temperature (weather). The parameters available when choosing a the <i>Control method</i> = <i>Weather control</i>.</p> <ul style="list-style-type: none"> <i>Heating curve</i> – choice in the form of a graph of the heating curve, in range of 10..42°C, appropriate for the type of building. The higher heating curve the higher the temperature of the water in the heating circuit. <i>Curve parallel move</i> – parameter enables to readjust the heating curve.
Preset temperature	When <i>Control method</i> = <i>Continous control</i> then the heat source is turned off when you reach the <i>Preset temperature</i> . When the temperature falls to the heat source is turned on again. This parameter is not available when <i>Control method</i> = <i>Weather control</i> .
Decrease of work mode	When the <i>Control method</i> = <i>Continous control</i> , decrease the preset temperature water in circulation during the <i>Economic</i> mode and <i>Auto</i> mode and during operation time schedule. In other modes temperature water circuit remains constant.
Decrease of thermostat	This parameter can be used only when <i>Room thermostat</i> = ON. Exceeding a preset room temperature causes decreasing preset temperature of water in the heating circuit by <i>Decrease of thermostat</i> value. Decreasing the preset temperature takes place upon contact trips (by opening) the thermostat. Preset temperature of water inside the heating circuit is not changed if <i>Decrease of thermostat</i> = 0. Parameter disappears when <i>Room thermostat</i> = OFF.
OFF by thermostat	Stopping the flow of water in the heating circuit when the thermostat contact (by opening) by turning off the circulation pump.
Start pump temp.	Above this parameter followed the inclusion of the circulating pump and the opening of the valve actuator circuit regulated.
Min. temperature	The minimum preset temperature of water in the heating circuit.
Max. temperature	The maximum preset temperature of water in the heating circuit.
Valve full opening time	Read valve full opening time from a servo housing, e.g. It is usually located on a servo nameplate and within a range of 90 – 180s.
Valve input dead zone	Parameter setting defining a temperature dead zone for the heating circuit. The controller controls a servo in such way that the temperature measured by a circuit sensor is equal to a preset value. Nevertheless in order to avoid frequent servo movements which can shorten its life, adjustment is carried out only when the measured water temperature is lower or higher than the mixer dead zone.
Valve dynamic	The reaction time of the valve actuator to position change. Amplification of the valve control algorithm.
Valve delay	The mixer valve actuator moved only after this time.

14.2 Heat source

Support	ON or OFF the support heat source for the heating circuit.
Histeresis	Hysteresis for heat source. The heat source is turns on at a preset temperature of water - <i>Hysteresis</i> . The heat source is turns off at the preset temperature of water + <i>Hysteresis</i> .
Min. temperature	The minimum temperature of the heat source.
Max. temperature	The maximum temperature of the heat source.
Buffer	<p>Buffer support:</p> <ul style="list-style-type: none"> <i>No</i> – heating circuit is operating, but the heat source is not heated up despite the heat source preset temperature drop. <i>Yes</i> – the heating circuit operation is off, the heat source operates independently in order to increase its temperature to the <i>Buffer preset temperature value</i>.
Buffer preset temp.	Temperature for the heat source, when the buffer support is turned on.

HW priority	<ul style="list-style-type: none"> • <i>ON</i> – When the temperature of the heat source is lower than the <i>Min. temperature</i> for the circuit, the controller lowers the circuit preset temperature, but only when there is no active reduction from the operation mode. • <i>OFF</i> – the regulator does not reduce the circuit preset temperature.
Cooling temp.	Temperature value at which heat excess is discharged to the heating circuit. It is protection against overheating.
OFF by thermostat	Turns off heat source when the starting thermostat contact.
Increase temp.	Increase of the heat source preset temperature above the heating circuit preset temperature.

14.3 Protection

Return sensor	<i>Turns on or off</i> support of the return temperature sensor. Enabling the sensor support shows additional parameters related with the function of protecting the boiler return from cold water. It is realized through a mixing valve with an electric actuator. Note: Do not turn sensor support if there is no electric actuator mounted on the valve! This function is not available when the return sensor is not connected or its support is disabled. Function activation results in valve closing.
Min. temperature	The temperature below which the electric actuator turn a blind mixing valve.
Hysteresis	Electric actuator will return to normal working at return temperature \geq <i>Min. temperature + Hysteresis</i> .
Closing the valve	It is % opening to the mixing valve during active the return protection function. Note: The valve closes with an accuracy of $\pm 1\%$.
Frost protection	<i>ON</i> or <i>OFF</i> frost protection function.
Frost protection delay	Time delay for enable frost protection function. Description later in this manual.
Frost protection temp.	The temperature below which the frost protection function is activated . Description later in this manual.

14.4 Other parameters

Room thermostat	<i>ON</i> or <i>OFF</i> supporting the room thermostat (NO-NC).
Temperature correction	Additional correction of the errors for the temperature sensor: T1 - heating circuit, T2 – external, T3 – return, T4 - boiler.
External sensor	Enable support external temperature sensor (weather) for controlling the heating circuit. In the event of external sensor damage on the screen displays the message " Damage sensor external temperature ". Enabling support cause additional parameters in the menu to the weather control.
Manual control	Manually turn <i>ON</i> or <i>OFF</i> working CH pump, mixer actuator, contact the heat source in order to control the correctness of their actions. Note: The long time activation of the pump - can be damaged this pump.
Screed drying	<i>Activating or Deactivating</i> the screed floor drying function (heating by floor circuit). Schedule of temperature changes in time is shown on the screen in the form of graphs appropriate for programs P1..P7. Select the correct program for the used type of screed and environmental conditions. Drying is performed by a corresponding change in floor circuit temperature in the range 10..50°C in a time of 30 days. Drying can be deactivating at any time. Re-activation function makes that the drying works all over again for 30 days.
Restore defaults settings	Selecting <i>YES</i> will reload all the factory settings.

15 Function

15.1 Prompts

The controller reports on the main screen prompts alarm indicating the status of the controller and damage the sensors, so that the user can take appropriate steps to eliminate damage or preventing a hazardous situation.

Reported by the controller prompts are:

1. Damage heating circuit sensor temperature.
2. Damage sensor external temperature.
3. Damage sensor return temperature.
4. Damage sensor heat source temperature.
5. Frost protection active!.
6. Cooling boiler!.

15.2 Heating circuit

Settings for heating circuit without weather sensor.

Should disable the external temperature sensor in the *External sensor* from the service menu and then It is necessary to manually set the required water temperature in the heating mixer circuit using parameter Preset mixer temp., e.g. at a value of 50°C. The value should allow to obtain the required room temperature. After connecting room thermostat, it is necessary to set a value of decrease in preset temperature by thermostat (parameters *Decrease of thermostat*) e.g. at 5°C. This value should be selected by trial and error. The room thermostat can be a traditional thermostat (NO-NC). Upon activation of the thermostat, the preset mixer circuit temperature will be decreased, which, if proper decrease value is selected, will stop growth of temperature in the heated room.

Settings for heating circuit with weather sensor.

Shouldn't disable the external temperature sensor in the *External sensor* from the service menu.

Using parameter *Curve parallel move*, set preset room temperature following the formula: Preset room temperature = 20°C + Curve parallel move.

In this setup, it is possible to connect a room thermostat which will equalize the inaccuracy of selecting heating curve, if the selected heating curve value is too high. In such case,

it is necessary to set the value of parameter *Decrease by thermostat*, e.g. at 2°C. After opening of the thermostat contacts, the preset mixer circuit temperature will be decreased, which, if proper decrease value is selected, will stop growth of temperature in the heated room.

Weather control.

For the heating circuit can be turned on weather control, which requires the connection of external temperature sensor. It should enable the external temperature sensor by setting:

Service settings → **External sensor** = ON - cause additional menu **Weather control**.

The heating circuit water preset temperature is calculated basing on the temperature prevailing outside the building. The colder it is outside, the higher water temperature in the heating circuit is. This relation is shown in the controller in the form of heating curve.

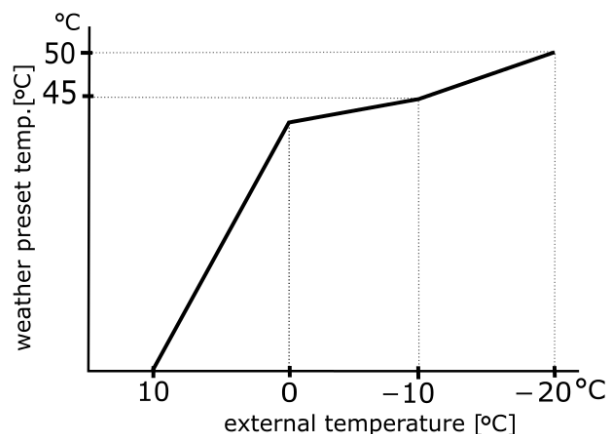

The heating curve can be changed in a graph from the system menu, within the range for the weather preset temperature. It is a reflection of the thermal characteristics of the building. If the building is less insulated then the heating curve should be greater. Heating curve should be selected experimentally by changing it in a few day intervals. During trial and error selection of appropriate heating curve, it is necessary to exclude influence of the room thermostat on regulator operation (regardless of whether the room thermostat is connected or not), by setting the parameter: **Service settings** → **Room thermostat** = OFF.

After choosing the proper heating curve, the *circuit preset temperature* is calculated according to the outside temperature. As a result if the heating curve is appropriate for

the building, the room temperature remains constant regardless of the temperature outside.

The regulator introduced value for the heating curve for underfloor heating:

external t. +10	->	preset t. =	24
external t. 0	->	preset t. =	28
external t. -10	->	preset t. =	32
external t. -20	->	preset t. =	36

and radiators system:

external t. +10	->	preset t. =	40
external t. 0	->	preset t. =	47
external t. -10	->	preset t. =	55
external t. -20	->	preset t. =	65

Guidelines for selecting a proper heating curve:

- if at dropping external temperature, room temperature increases, the selected heating curve is too high,
 - if at dropping external temperature, room temperature also drops, the selected heating curve is too low,
 - if during frost, room temperature is proper and too low when the weather is warmer, it is recommended to increase heating curve parallel shift and decrease the heating curve,
 - if during frost, room temperature is too low and too high when the weather is warmer, it is recommended to decrease heating curve parallel shift and increase the heating curve.
- Poorly warmed buildings require setting higher heating curves. Whereas for well heating buildings, heating curve will have a smaller value.

The regulator can increase or decrease the preset temperature, calculated in accordance with the heating curve, if it exceeds the temperature range for the given circuit set in parameters *Min. temperature* and *Max. temperature*.

15.3 Frost protection

Frost protection function is applicable only to active controller work modes: *OFF* or *AUTO-ECO*. In *AUTO-ECO* mode, this function is executed only during a night time decrease.

The function is activated in the menu:

Services settings → **Protection** → **Frost protection**

Description of frost protection against the external temperature sensor readings.

When the external temperature drops below 3°C, an *Frost protection delay*, e.g. 4h must expire. If after this time the external temperature is still under 3°C, a heating circuit pump will be activated for 30 minutes. After 30 minutes temperature on the mixer sensor will be checked and if the temperature is lower than 13°C to preset temperature heat source is set to *Frost protection temp.* value. Turning off the pump and the heat source will take place only after the external temperature rises above 3°C. The pump circuit is also activated when there is a risk of freezing circuit.

Adjustable circuit.

When the external temperature drops below 3°C, an *Frost protection delay*, e.g. 4h must expire. If after that time the external temperature does not rise above 3°C the heating circuit pump will turn on for the duration of 15 minutes. After 15 minutes, water temperature in the circuit will be checked. If it is higher than 13 °C, the pump will be stopped. If it is lower than 13 °C, the pump will continue its operation and heating circuit will be heated by a heat source up to a *Frost protection temp.* value. The pump will be stopped unless the external temperature exceeds 3°C.

If the heating circuit must be turned on during this period, instead of off the controller must be activated for the heating circuit working mode: *OFF* or *AUTO-ECO*.



During a risk of frost, do not connect the controller from the mains supply.

15.4 Power stoppage

In case of power stoppage the controller returns to operation mode in which it was before stoppage.

15.5 Prevention cooling

The function tries to cool down the heat source before switching the regulator into the alarm state of overheat of the heat source.

15.6 Pump anti standstill function

The controller performs the function of protecting pump from anti standstill. It involves the periodic switching (which 167h for a few seconds). This protects the pump against immobilization due to scaling. Therefore, during a break in the use of the controller, the controller power supply should be connected.

15.7 Fuse replacement

Cut off power supply to the controller before fuse replacement.

Use 1.25A time-delay subminiature fuse with minimum interrupting current of 100A should be used, as per IEC 60127 standard.

To replace open controller's enclosure and replace burnt fuse with a new one.



16 Storage and transport conditions

The controller cannot be exposed to immediate effects of atmospheric conditions i.e. rain or sunrays. Temperature of storage should be within scope 0...65°C.

17 Technical data

Power	230V~, 50Hz
Maximum current consumption with loaded outputs	3(3)A
Maximum current consumption without loaded outputs	0,02A
Output current Pump: Mixer actuator ON: Mixer actuator OFF: Heat source contact:	1,5(1,5)A/230V 0,5(0,5)A/230V 0,5(0,5)A/230V 0,5(0,5)A/230V
Controller's level of protection	IP20
Outer temperature	0...40°C
Storage temperature	0...65°C, without direct sunlight
Relative humidity	10 - 90%, without steam condensation
Measuring inputs, temperature (low voltage)	T1 – mixer temp. T2 – external temp. T3 – return temp. T4 – heat source temp. T – room thermostat input
Measuring scope of sensors' temperature CT10	0..100°C
Measuring scope of sensors' temperature CT6-P	-35..40°C
Accuracy of measuring temperature with sensors CT10 and CT6-P	±2°C
Clamps for network and signal	Screw clamps, wire profile up to 2,5mm ² , tighten moment 0,4Nm, isolation lenght 6mm
Display	Graphic 128x64
Dimensions	140x99x43 mm
Weight	280g
Norms	PN-EN 60730-2-9 PN-EN 60730-1
Software class	A
Mounting	on the wall

Note:

.....



SALUS – Controls

ul. Rolna 4

43-262 Kobielice

Poland

www.salus-controls.pl